

Tecnodin **Volantes** Plásticos

Pág.		Pág.	
45		48	
45		48	
45		48	
45		49	
46		49	
46		49	
46		50	
46		50	
47		50	
47		51	
47			
47			

110031S VOLANTE ROMA

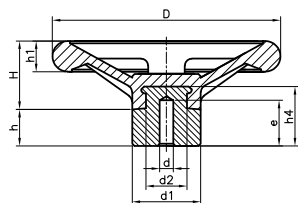

Código	D	H	d	e	d2	h4	d1	h	h1	Color
11003110601	100	31	5,25	20	22	26	30	16	13,5	Negro
11003112601	125	37	8	25	28	32	40	22	14	Negro
11003115601*	150	50	10	30	30	55	50	30	18	Negro
11003117601	175	51	10	30	30	55	50	30	20	Negro
11003120601	200	70	10	30	30	55	50	30	26	Negro
11003130601*	300	98	10	30	34	60	60	18	30	Negro

(*) 5 radios

Núcleo de hierro tratado.
PF: Resina fenólica negra FS 31 DIN 7708.

110031Sa VOLANTE ROMA CON ASIENTO PARA MANILLA

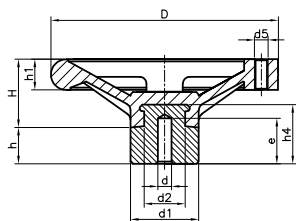

Código	D	H	d	e	d2	h4	d1	h	h1	d5	Color
11003110651	100	31	5,25	20	22	26	30	16	13,5	M6	Negro
11003112651	125	37	8	25	28	32	40	22	14	M6	Negro
11003115651*	150	50	10	30	30	55	50	30	18	M8	Negro
11003117651	175	51	10	30	30	55	50	30	20	M10	Negro
11003120651	200	70	10	30	30	55	50	30	26	M12	Negro

(*) 5 radios

Núcleo de hierro tratado.
Asiento roscado para manillas fijas y giratorias
códigos 110041, 110036 y 110037.
PF: Resina fenólica negra FS 31 DIN 7708.

110032H VOLANTE EUROPEO CON CASQUILLO LISO

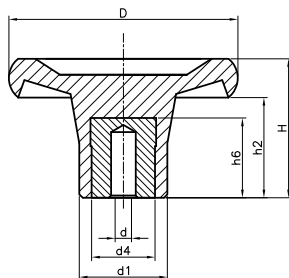

Código	D	H	d	d1	h2	h6	d4	Color
11003204301	45	26,5	5,25	20	17	17	14	Negro
11003206302	65	31	5,25	25	20	22	18	Negro
11003208302	80	38	5,25	30	25	22	18	Negro

Casquillo de hierro tratado.
PF: Resina fenólica negra FS 31 DIN 7708.

110032P VOLANTE EUROPEO CON AGUJERO PASANTE CUADRADO

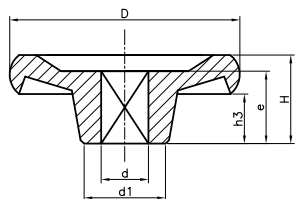

Código	D	H	d	e	h3	d1	Color
11003206401	65	20	10x10	15	11	26	Negro
11003208401	80	21	10x10	15	9	34	Negro
11003210401	100	23	10x10	15	5	44	Negro
11003212401	125	31	12x12	21	10	40	Negro
11003215401	150	32	12x12	21	7	50	Negro

Agujero pasante cuadrado.
PF: Resina fenólica negra FS 31 DIN 7708.

110032S VOLANTE EUROPEO CON NÚCLEO

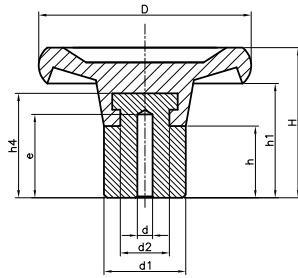

Código	D	H	d	e	d2	h4	d1	h	h1	Color
1103204601	45	33	5,25	20	11	20	20	24	21	Negro
11003206601	65	39	5,25	22	19	29	25	24	28	Negro
11003208601	80	43	5,25	20	22	26	30	24	31	Negro
11003210601	100	52	8	25	28	32	40	25	34	Negro
11003212601	125	64	8	25	28	32	40	25	43	Negro
11003215601	150	82	10	30	35	50	50	30	57	Negro
11003217601	175	84	10	30	35	50	50	30	64	Negro
11003220601	200	86	10	30	35	50	50	30	64	Negro

Núcleo de hierro tratado.
PF: Resina fenólica negra FS 31 DIN 7708.

110032Sa VOLANTE EUROPEO CON NÚCLEO Y ASIENTO PARA MANILLA

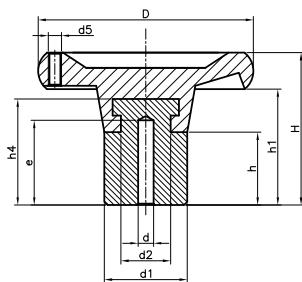

Código	D	H	d	e	d2	h4	d1	h	h1	d5	Color
11003210651	100	52	8	25	28	32	40	25	34	M6	Negro
11003212651	125	64	8	25	28	32	40	25	43	M8	Negro
11003215651	150	82	10	30	35	50	50	30	57	M10	Negro
11003217651	175	84	10	30	35	50	50	30	64	M10	Negro
11003220651	200	86	10	30	35	50	50	30	64	M12	Negro

Núcleo de hierro tratado.
Asiento roscado para manillas fijas y giratorias
códigos 110041, 110036 y 110037.
PF: Resina fenólica negra FS 31 DIN 7708.

110032T VOLANTE EUROPEO CON ESPIGA ROSCADA

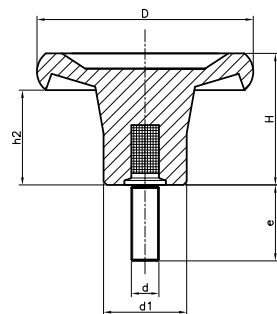

Código	D	H	d	e	d1	h2	Color
11003204501	45	26	M8	27	20	16	Negro
11003206506	65	30	M10	33	25	19	Negro
11003208502	80	37	M12	40	30	24	Negro

Espiга roscada de hierro tratado.
PF: Resina fenólica negra FS 31 DIN 7708.

110073 MANDO TALADRO Q

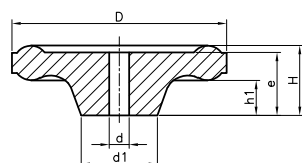

Código	D	H	d	e	d1	h1	Color
11007335201	35	15	5x5	13	13	9	Negro
11007350201	50	22	7x7	17	21	10	Negro
11007361201	61	20	7x7	18	21	10	Negro
11007371201	71	24	7x7	22	27	12	Negro
11007371202	71	24	8x8	22	27	12	Negro

Agujero cuadrado.
PF: Resina fenólica negra FS 31 DIN 7708.

110074 MANDO CALEFACCIÓN

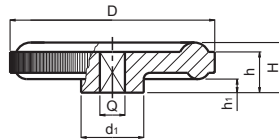

Código	D	H	Q	h	d1	h1	Color
11007449201	49	12	6	8	15	-	Negro
11007456201	56	15	7	11,5	20	5	Negro

Q = Agujero cuadrado.

PF: Resina fenólica negra FS 31 DIN 7708.

110083H MANDO SIX CON CASQUILLO LISO

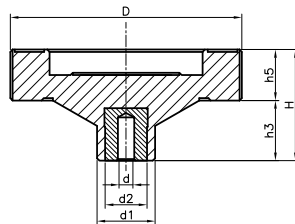

Código	D	H	d	d1	d2	h5	h3	Color
11008306301	65	36	5,25	25	18	15	22	Negro
11008308301	80	38	5,25	25	18	16	22	Negro

Casquillo liso de hierro tratado.

PF: Resina fenólica negra FS 31 DIN 7708.

110083S MANDO SIX CON NÚCLEO

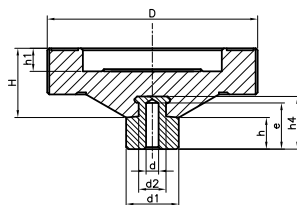
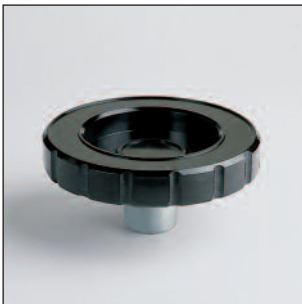

Código	D	H	d	d1	d2	e	h1	h4	h	Color
11008306601	65	30	5,25	25	19	15	10	29	15	Negro
11008308601	80	30	5,25	25	19	15	10	29	15	Negro
11008310601	100	33	5,25	25	19	15	11	29	15	Negro
11008313601	130	33	5,25	30	20	20	11	26	25	Negro

Núcleo de hierro tratado.

PF: Resina fenólica negra FS 31 DIN 7708.

110083Sa MANDO SIX CON NÚCLEO Y ASIENTO PARA MANILLA

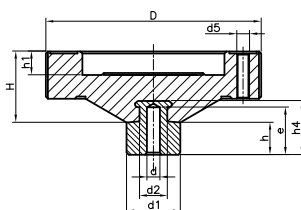

Código	D	H	d	d1	d2	d5	e	h1	h4	h	Color
11008310651	100	33	5,25	25	19	M6	15	11	29	15	Negro
11008313651	130	33	5,25	30	20	M8	20	11	26	25	Negro

Núcleo de hierro tratado.

Asiento roscado para manillas fijas y giratorias
códigos 110041, 110036 y 110037.

PF: Resina fenólica negra FS 31 DIN 7708.

110083T MANDO SIX CON ESPIGA ROSCADA

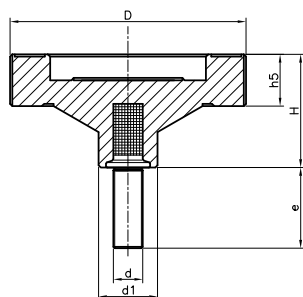

Código	D	H	d	e	d1	h5	Color
11008306501	65	37	M10	33	25	15	Negro
11008308502	80	38	M12	40	25	16	Negro

Espiga roscada de hierro tratado.
PF: Resina fenólica negra FS 31 DIN 7708.

110084D* VOLANTE VÁLVULA

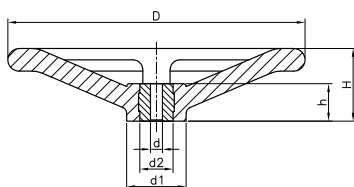

Código	D	H	d1	d	d2	h	Color
11008412401	128	38	30	10	20	21	Negro
11008415401	150	61	34	10	25	31	Negro
11008416401	160	50	35	10	25	31	Negro
11008420401	200	54	48	10	25	31	Negro
11008425401	250	61	50	10	25	31	Negro

Núcleo pasante de hierro tratado.
PF: Resina fenólica negra FS 31 DIN 7708.

470013 VOLANTE 3 BRAZOS CON CASQUILLO LISO

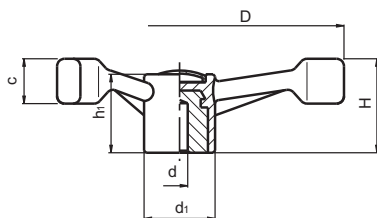

Código	D	H	h1	d1	d	dm	c	Color	Tapón
47001314301	137	45	39,5	38	8	22	23	Negro	Gris
47001318301	177	56	42,5	38	8	22	24	Negro	Gris
47001322301	221	61	46	38	8	22	28	Negro	Gris

Casquillo liso pasante cincado.
PA: Poliamida negra reforzada.
Tapón central de color gris RAL 7035.
dm=diámetro máximo a mecanizar el casquillo central.
Sobre pedido podemos suministrar el tapón en diferentes colores.
Para cantidades mínimas podemos suministrar el casquillo central roscado o con chavetero.

470030H VOLANTE 4 BRAZOS CON CASQUILLO LISO



Código	D	H	h1	h4	h2	h3	e	d1	d	dm	d2	C	A	Color	Tapón	
47003031301	308	66	45,5	3	46	7,5	38	83	8	H11	26	35,5	20	45,5	Negro	Gris

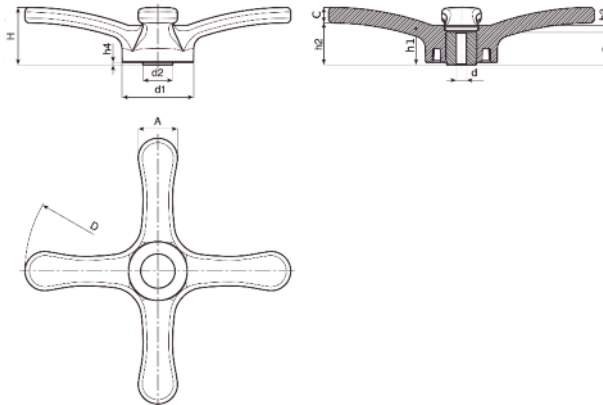

Casquillo liso pasante cincado.
 PA: Poliamida reforzada negra.
 Tapón central de color gris RAL 7035.
 dm=diámetro máximo a mecanizar el casquillo central.
 Sobre pedido podemos suministrar el tapón en diferentes colores.
 Para cantidades mínimas podemos suministrar el casquillo central roscado o con chavetero.

470031D* VOLANTE 2R CON CASQUILLO LISO

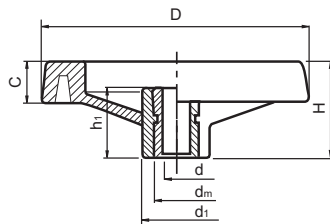

Código	D	H	d1	C	h1	d	dm	Color	Tapón
47003108301	80	34	24,5	14	26	5	12	Negro	Gris
47003110301	99	43	28	16	33	5	16	Negro	Gris
47003113301	129	50	32	20	36	5	18	Negro	Gris
47003116301	159	57	40	24	40,5	8	22	Negro	Gris
47003120301	198	61,5	51	28	39,5	8	22	Negro	Gris
47003125301	252	70	55,5	32	47	8	28	Negro	Gris
47003135301	346	80	67,5	37	49,5	8	30	Negro	Gris

Casquillo liso pasante cincado.
 PA: Poliamida negra reforzada.
 Tapón central de color gris RAL 7035.
 dm=diámetro máximo a mecanizar el casquillo central.

470031D*a VOLANTE 2R CON CASQUILLO LISO Y ASIENTO PARA MANILLA



Código	D	H	M	d1	C	h1	d	dm	Color	Tapón
47003108701	80	34	M6	24,5	14	26	5	12	Negro	Gris
47003110701	99	43	M6	28	16	33	5	16	Negro	Gris
47003113701	129	50	M8	32	20	36	5	18	Negro	Gris
47003116701	159	57	M8	40	24	40,5	8	22	Negro	Gris
47003120701	198	61,5	M8	51	28	39,5	8	22	Negro	Gris
47003125702	252	70	M10	55,5	32	47	8	28	Negro	Gris
47003135701	346	80	M10	67,5	37	49,5	8	30	Negro	Gris

Casquillo liso pasante cincado.
 PA: Poliamida negra reforzada.
 Tapón central de color gris RAL 7035.
 dm=diámetro máximo a mecanizar el casquillo central.
 M= Asiento roscado para manillas modelos 4733, 4734 y 4735 (no incluidas).

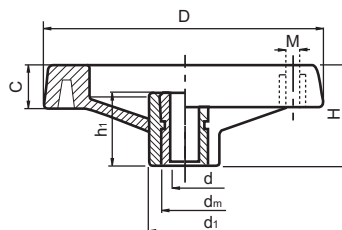

470031Dm VOLANTE 2R CON CASQUILLO LISO Y MANILLA PLEGABLE



Código	D	H	d1	C	h1	d	dm	L	Color	Tapón
47003113801	129	53	32	23	32	5	18	58	Negro	Gris
47003116801	159	55	40	24	33,5	5	22	71	Negro	Gris
47003135801	346	80	67,5	37	49,5	8	30	64	Negro	Gris

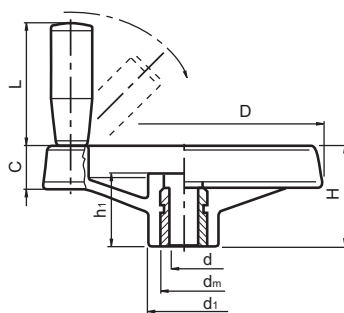

Casquillo liso pasante cincado.
PA: Poliamida negra reforzada.
Tapón central de color gris RAL 7035.
dm=diámetro máximo a mecanizar el casquillo central.
Manilla plegable montada en el volante.

470032D* VOLANTE MACIZO CON CASQUILLO LISO

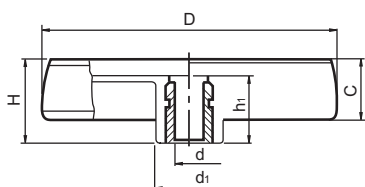

Código	D	H	d1	C	h1	d	dm	Color	Tapón
47003208301	81	33	25	17	29	5	12	Negro	Gris
47003210301	100	39	30	20,5	34	5	16	Negro	Gris
47003212301	125	44	36	24	37	5	18	Negro	Gris
47003215301	150	54	38	29	44	8	22	Negro	Gris
47003217301	173	57	40	31,5	47	8	22	Negro	Gris
47003220301	202	59	44	35	49	8	28	Negro	Gris
47003225301	249	68	59	39	58	8	28	Negro	Gris

Casquillo liso pasante cincado.
PA: Poliamida negra reforzada.
Tapón central de color gris RAL 7035.
dm=diámetro máximo a mecanizar el casquillo central.

470032D*a VOLANTE MACIZO CON CASQUILLO LISO Y ASIENTO PARA MANILLA

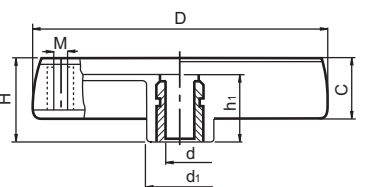

Código	D	H	d1	C	h1	d	M	dm	Color	Tapón
47003208701	81	33	25	17	29	5	M6	12	Negro	Gris
47003210701	100	39	30	20,5	34	5	M6	16	Negro	Gris
47003212701	125	44	36	24	37	5	M8	18	Negro	Gris
47003215701	150	54	38	29	44	8	M10	22	Negro	Gris
47003217701	173	57	40	31,5	47	8	M10	22	Negro	Gris
47003220701	202	59	44	35	49	8	M10	28	Negro	Gris
47003225701	249	68	59	39	58	8	M10	28	Negro	Gris

Casquillo liso pasante cincado.
PA: Poliamida negra reforzada.
Tapón central de color gris RAL 7035.
dm=diámetro máximo a mecanizar el casquillo central.
M= Asiento roscado para manillas modelos 470033, 470034 y 470035 (no incluidas).

470032D*mp**VOLANTE MACIZO CON CASQUILLO LISO Y MANILLA PLEGABLE**

Casquillo liso pasante cincado.
 PA: Poliamida negra reforzada.
 Tapón central de color gris RAL 7035.
 dm=diámetro máximo a mecanizar el casquillo central.
 Manilla plegable montada en el volante.

Código	D	H	d1	C	h1	d	dm	L	Color	Tapón
*47003208781	80	33	25	18	29	5	12	38	Negro	Gris
*47003210781	100	42	30	24	36	5	16	48	Negro	Gris
47003212781	124	48	36	26,5	40	5	18	38	Negro	Gris
47003215781	149	53	38	28,5	44	8	22	58	Negro	Gris
47003217781	174	58	40	33,5	48	8	28	80	Negro	Gris
47003220781	198	63	44	38,5	53	8	28	90	Negro	Gris
47003225781	250	67	60	38	58	8	28	90	Negro	Gris

* Extremo de la manilla plegado sobre el centro del volante.

