

# Tecnodin**Pomos**Metálicos

	Pág.	Pág.
	37	40
	37	40
	38	41
	38	41
34	38	41
34	38	41
34	39	42
35	39	42
35	39	42
36	39	
36	40	
36	40	

## 3705F DIN 6336 F DE FUNDICIÓN SIN MECANIZAR



Fe: Fundición gris, arenada.

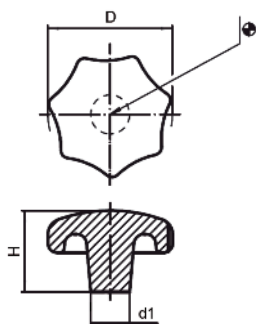

Código	D	H	d1
370503000	32	21	12
370504000	40	26	14
370505000	50	34	18
370506000	63	42	20
370508000	80	52	25

## 3705C DIN 6336 C DE FUNDICIÓN CON ROSCA DIRECTA



Rosca directa.  
Fe: Fundición gris, arenada

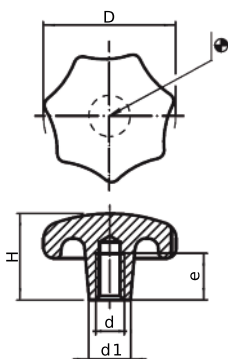

Código	D	H	d1	d	e
370500432	32	20	12	M6	12
370500440	40	25	14	M8	15
370500450	50	32	18	M10	18
370500463	63	40	20	M12	22
370500480	80	50	25	M16	28

## 3705E DIN 6336 E CON ROSCA DIRECTA PASANTE



Rosca directa pasante.  
Fe: Fundición gris, arenada.

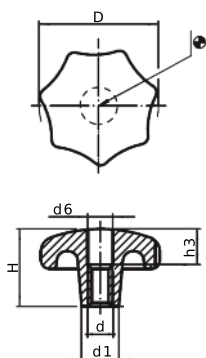

Código	D	H	d1	d6	d	h3
370500332	32	20	12	6,4	M6	10
370500340	40	25	14	8,4	M8	12
370500350	50	32	18	10,5	M10	16
370500363	63	40	20	13,0	M12	20
370500380	80	50	25	17,0	M16	30

## 3707F DIN 6335 F DE FUNDICIÓN SIN MECANIZAR



Fe: Fundición gris, arenada.

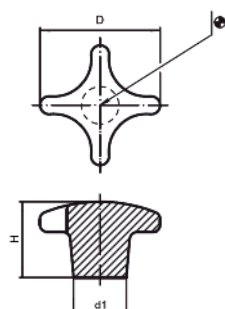

Código	D	H	d1
370703000	32	21	12
370704000	40	26	14
370705000	50	34	18
370706000	63	42	20
370708000	80	52	25
370710000	100	65	32

### 3707C DIN 6335 C DE FUNDICIÓN CON ROSCA DIRECTA



Rosca directa.  
Fe: Fundición gris, arenada.

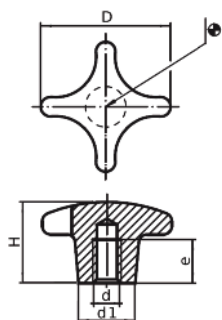

Código	D	H	d1	d	e
370700432	32	20	12	M6	12
370700440	40	25	14	M8	15
370700450	50	32	18	M10	18
370700463	63	40	20	M12	22
370700480	80	50	25	M16	28
370700490	100	63	32	M20	36

### 3707E DIN 6335 E DE FUNDICIÓN CON ROSCA DIRECTA PASANTE



Rosca directa pasante.  
Fe: Fundición gris, arenada.

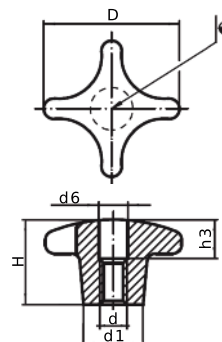

Código	D	H	d1	d6	d	h3
370700332	32	20	12	6,4	M6	10
370700340	40	25	14	8,4	M8	12
370700350	50	32	18	10,5	M10	16
370700363	63	40	20	13,0	M12	20
370700380	80	50	25	17,0	M16	30
370700390	100	63	32	21,0	M20	38

### 3707F INOX DIN 6335 F DE ACERO INOXIDABLE SIN MECANIZAR



INOX: Acero inoxidable 1.4305.  
Acabado mate.

**INOX**  
Acero  
Inoxidable

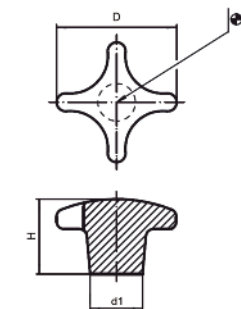

Código	D	H	d1
370710032	32	21	12
370710040	40	26	14
370710050	50	34	18
370710063	63	42	20

### 3707C INOX DIN 6335 C DE ACERO INOXIDABLE CON AGUJERO ROSCADO



Agujero roscado.  
INOX: Acero inoxidable 1.4305.  
Acabado mate.

**INOX**  
Acero  
Inoxidable

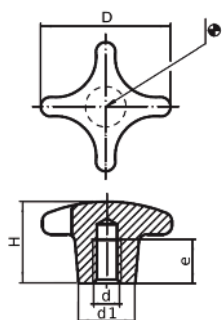

Código	D	H	d1	d	e
370710432	32	20	12	M6	12
370710440	40	25	14	M8	15
370710450	50	32	18	M10	18
370710463	63	40	20	M12	22

### 3707E DIN 6335 E DE ACERO INOXIDABLE CON AGUJERO PASANTE ROSCADO



**INOX**  
Acero  
Inoxidable

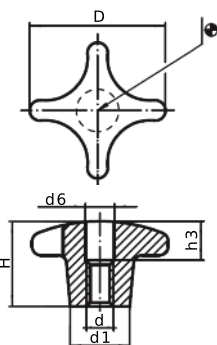

Código	D	H	d1	d6	d	h3
370710332	32	20	12	6,4	M6	10
370710340	40	25	14	8,4	M8	12
370710350	50	32	18	10,5	M10	16
370710363	63	40	20	13,0	M12	20

Agujero roscado pasante.  
INOX: Acero inoxidable 1.4305.  
Acabado mate.

### 3709E DIN 6303 E DE ACERO CON ROSCA DIRECTA PASANTE

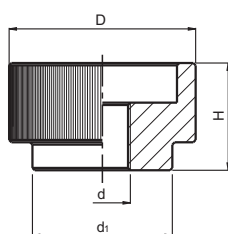

Código	D	H	d	d1	Acabado
370920105	20	12	M5	14	Pavonado
370924106	24	14	M6	16	Pavonado
370930108	30	17	M8	20	Pavonado
370936110	36	20	M10	28	Pavonado
370940112	40	24	M12	32	Pavonado

Rosca directa pasante.  
Fe: Acero de decoletaje pavonado.

### 3711C POMO MACIZO CON ROSCA DIRECTA EN INOX



**INOX**  
Acero  
Inoxidable

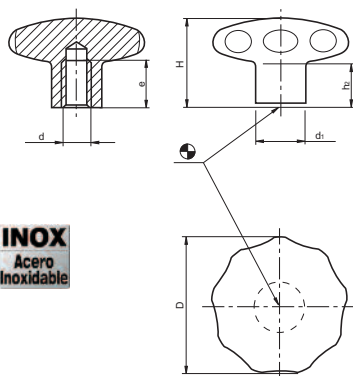

Código	D	H	d1	e	d	h2	Acabado
371100645	40	30,5	18	12	M6	15	Mate
371100646	40	30,5	18	12	M8	15	Mate
371100655	50	34,0	21	15	M8	17	Mate
371100656	50	34,0	21	15	M10	17	Mate
371100665	60	39,0	25	18	M10	18	Mate
371100666	60	39,0	25	18	M12	18	Mate

Rosca directa.  
INOX: acero inoxidable 1.4305.  
Diseñado para aplicaciones que requieren un alto grado de higiene.

### 3711E POMO MACIZO CON ROSCA DIRECTA PASANTE EN INOX

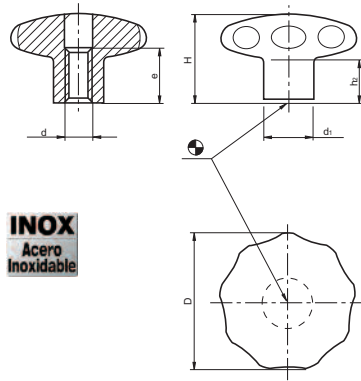
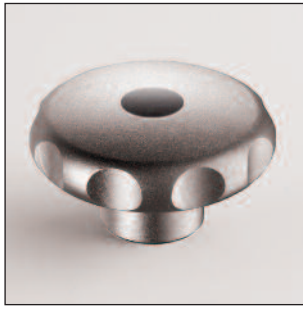

**INOX**  
Acero  
Inoxidable

Rosca directa pasante.  
INOX: acero inoxidable 1.4305.  
Diseñado para aplicaciones que requieren un alto grado de higiene.

Código	D	H	d1	e	d	h2	Acabado
371100644	40	30,5	18	13	M8	15	Mate
371100654	50	34,0	21	16	M10	17	Mate
371100664	60	39,0	25	20	M12	18	Mate

### 3711G POMO MACIZO CON TALADRO LISO EN INOX

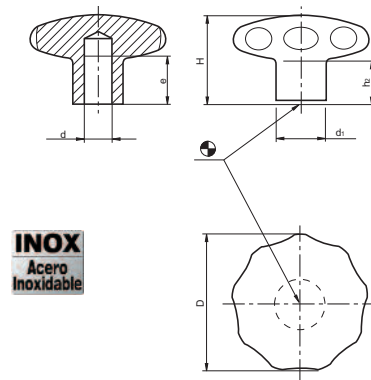

**INOX**  
Acero  
Inoxidable

Taladro ciego liso.  
INOX: acero inoxidable 1.4305.  
Diseñado para aplicaciones que requieren un alto grado de higiene.

Código	D	H	d1	e	d	h2	Acabado
371100643	40	30,5	18	12	8	15	Mate
371100653	50	34,0	21	15	10	17	Mate
371100663	60	39,0	25	18	12	18	Mate

### 3711C POMO ESTRELLA INOXIDABLE CON ROSCA DIRECTA

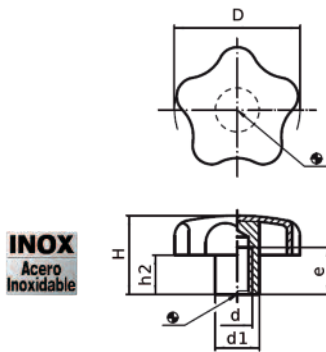

**INOX**  
Acero  
Inoxidable

Rosca directa.  
INOX: acero inoxidable 1.4301.  
Chapa estampada con núcleo soldado.

Código	D	H	d1	d	e	h2	Acabado
371100440	40	25	14	M8	15	12,5	Mate
371100450	50	32	18	M10	18	17,5	Mate
371100460	60	40	20	M12	22	21,0	Mate

### 3711G POMO ESTRELLA INOXIDABLE CON TALADRO LISO

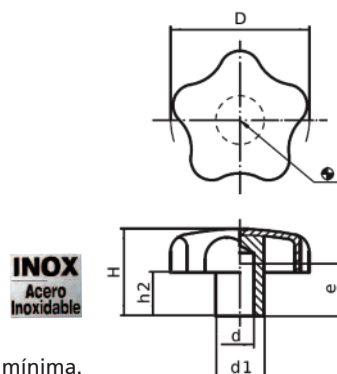

**INOX**  
Acero  
Inoxidable

Taladro liso ciego (d H7).  
La cota e indica la profundidad mínima.  
INOX: acero inoxidable 1.4301.  
Chapa estampada con núcleo soldado.

Código	D	H	d1	d	e	h2	Acabado
371100240	40	25	14	8	15	12,5	Mate
371100250	50	32	18	10	18	17,5	Mate
371100260	60	40	20	12	22	21,0	Mate



### 3711T POMO ESTRELLA INOXIDABLE CON ESPIGA ROSCADA



**INOX**  
Acero  
Inoxidable

Espiga roscada inoxidable.  
INOX: acero inoxidable 1.4301.  
Chapa estampada con núcleo soldado.

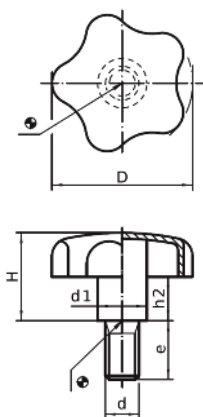

Código	D	H	d1	d	e	h2	Acabado
371100140	40	24	14	M8	20	12,0	Mate
371100144	40	24	14	M8	40	12,0	Mate
371100150	50	30	18	M10	20	16,5	Mate
371100154	50	30	18	M10	40	16,5	Mate
371100160	60	37,5	20	M12	30	20,0	Mate
371100164	60	37,5	20	M12	50	20,0	Mate

### 3749C DIN 6335 C ALUMINIO CON ROSCA DIRECTA



Rosca directa.  
AL: Aluminio, pulido.

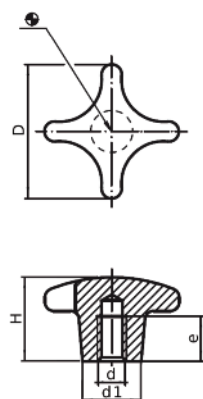

Código	D	H	d1	d	e	Acabado
374900840	40	25	14	M8	15	Pulido
374900850	50	32	18	M10	18	Pulido
374900863	63	40	20	M12	22	Pulido
374900880	80	50	25	M16	28	Pulido

### 3749E DIN 6335 E ALUMINIO CON ROSCA DIRECTA PASANTE



Rosca directa pasante.  
AL: Aluminio, pulido.

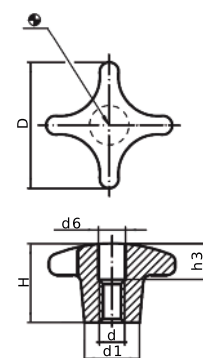

Código	D	H	d1	d	h3	d6	Acabado
374900740	40	25	14	M8	12	8,4	Pulido
374900750	50	32	18	M10	16	10,5	Pulido
374900763	63	40	20	M12	20	13,0	Pulido
374900780	80	50	25	M16	30	17,0	Pulido

### 3323G DIN 6335 G ALUMINIO CON TALADRO LISO



Taladro liso ciego.  
AL: Aluminio, pulido.

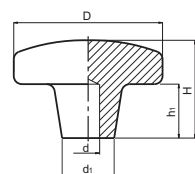

Código	D	H	d1	h1	d	Acabado
332304101	40	25	14	18	6	Pulido
332305101	50	32	18	21	6	Pulido
332306101	63	40	20	25	6	Pulido
332308101	80	50	25	32	6	Pulido

### 3323F DIN 6335 F ALUMINIO SIN MECANIZAR, SIN PULIR

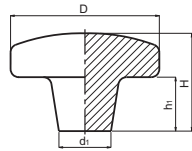

Código	D	H	d1	h1	Acabado
332304201	40	25	14	12	Sin Pulir
332305201	50	32	18	17	Sin Pulir
332306201	63	40	20	23	Sin Pulir
332308201	80	50	25	28	Sin Pulir

AL: Aluminio, sin pulir.

### 3753C DIN 6336 C ALUMINIO CON ROSCA DIRECTA

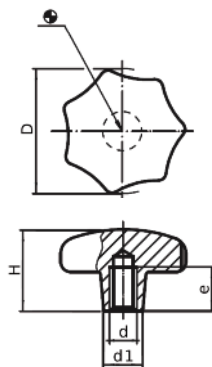

Código	D	H	d1	d	e	Acabado
375300840	40	25	14	M8	15	Pulido
375300850	50	32	18	M10	18	Pulido
375300863	63	40	20	M12	22	Pulido
375300880	80	50	25	M16	28	Pulido

Rosca directa.  
AL: Aluminio, pulido.

### 3753D DIN 6336 D ALUMINIO CON ROSCA DIRECTA PASANTE

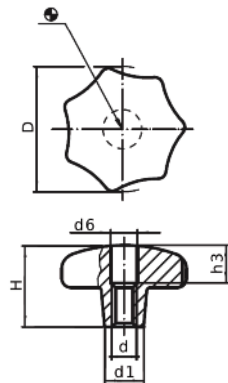

Código	D	H	d1	d6	d	h3	Acabado
375300740	40	25	14	8,4	M8	15	Pulido
375300750	50	32	18	10,5	M10	18	Pulido
375300763	63	40	20	13	M12	22	Pulido
375300780	80	50	25	17	M16	28	Pulido

Rosca directa pasante.  
AL: Aluminio, pulido.

### 3320G DIN 6336 G ALUMINIO SIN MECANIZAR, PULIDO

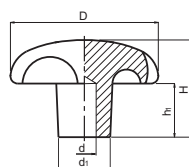

Código	D	H	d1	h1	d	Acabado
332004101	40	25	14	12	6	Pulido
332005101	50	32	18	16	6	Pulido
332006101	63	40	20	20	6	Pulido
332008101	80	50	25	25	6	Pulido

AL: Aluminio, pulido.

### 3320F DIN 6336 F ALUMINIO SIN MECANIZAR, SIN PULIR

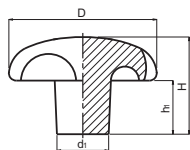

Código	D	H	d1	h1	Acabado
332004201	40	25	14	13	Sin Pulir
332005201	50	32	18	16	Sin Pulir
332006201	63	40	20	20	Sin Pulir
332008201	80	50	25	24	Sin Pulir

AL: Aluminio, sin pulir.

### 3766T DIN 653 TUERCA MOLETEADA PLANA CON ESPIGA ROSCADA

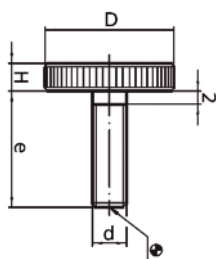

Código	D	H	d	e
376600073	12	2,5	M3	8
376600077	12	2,5	M3	16
376600093	16	3,5	M4	10
376600096	16	3,5	M4	16
376600113	20	4	M5	12
376600117	20	4	M5	20
376600134	24	5	M6	16
376600138	24	5	M6	25
376600154	30	6	M8	20
376600158	30	6	M8	30
376600174	36	8	M10	25
376600180	36	8	M10	40

Espiga roscada.  
Fe: Acero calidad 5,8, pavonado.

### 3766T DIN 653 TUERCA MOLETEADA PLANA CON ESPIGA ROSCADA EN INOX



**INOX**  
Acero  
Inoxidable

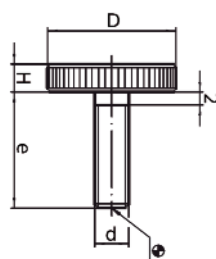

Código	D	H	d	e
376600293	16	3.5	M4	10
376600296	16	3.5	M4	16
376600313	20	4	M5	12
376600317	20	4	M5	20
376600334	24	5	M6	16
376600338	24	5	M6	25
376600354	30	6	M8	20
376600358	30	6	M8	30
376600374	36	8	M10	25
376600380	36	8	M10	40

Espiga roscada en acero inoxidable.  
INOX: acero inoxidable 1.4305, Mate.

### 3768D DIN 467 TUERCA MOLETEADA PLANA CON ROSCA PASANTE

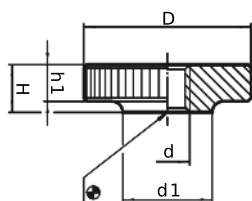

Código	D	H	d	d1	h1
376800030	12	3	M3	6	2,5
376800040	16	4	M4	8	3,5
376800050	20	5	M5	10	4
376800060	24	6	M6	12	5
376800080	30	8	M8	16	6
376800100	36	10	M10	20	8
376800120	40	12	M12	22	10

Rosca directa pasante.  
Fe: Acero calidad 5, pavonado.  
El código 376800120 no cumple con la norma DIN indicada.

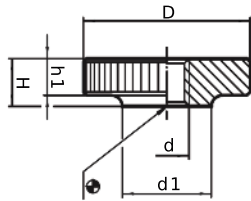

**3768D****DIN 467 TUERCA MOLETEADA PLANA CON ROSCA PASANTE EN INOX****INOX**  
Acero  
Inoxidable

Código	D	H	d	d1	h1
376800230	12	3	M3	6	2,5
376800240	16	4	M4	8	3,5
376800250	20	5	M5	10	4
376800260	24	6	M6	12	5
376800280	30	8	M8	16	6
376800300	36	10	M10	20	8

Rosca directa pasante.  
INOX: acero inoxidable  
1.4305, Mate.

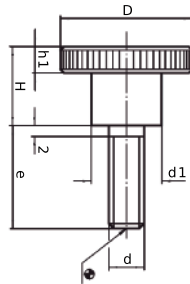
**3769T****DIN 464 TUERCA MOLETEADA CON CUELLO Y ESPIGA ROSCADA**

Código	D	H	d	e	h1	d1
376900076	12	7,5	M3	10	2,5	6
376900079	12	7,5	M3	16	2,5	6
376900095	16	9,5	M4	10	3,5	8
376900098	16	9,5	M4	16	3,5	8
376900115	20	11,5	M5	12	4	10
376900119	20	11,5	M5	20	4	10
376900136	24	15	M6	16	5	12
376900142	24	15	M6	30	5	12
376900154	30	18	M8	16	6	16
376900160	30	18	M8	30	6	16
376900175	36	23	M10	25	8	20
376900181	36	23	M10	40	8	20

Espiga roscada.  
Fe: Acero calidad 5,8, pavonado.

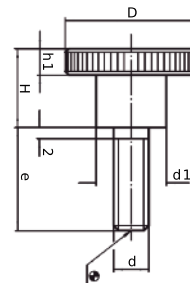
**3769T****DIN 464 TUERCA MOLETEADA CON CUELLO Y ESPIGA ROSCADA EN INOX****INOX**  
Acero  
Inoxidable

Código	D	H	d	e	h1	d1
376900295	16	9,5	M4	10	3,5	8
376900298	16	9,5	M4	16	3,5	8
376900315	20	11,5	M5	12	4	10
376900319	20	11,5	M5	20	4	10
376900336	24	15	M6	16	5	12
376900342	24	15	M6	30	5	12
376900354	30	18	M8	16	6	16
376900360	30	18	M8	30	6	16

Espiga roscada en acero inoxidable.  
INOX: acero inoxidable 1.4305, Mate.

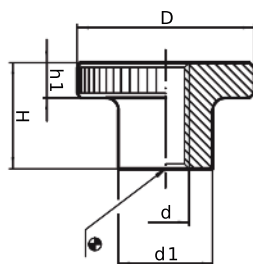
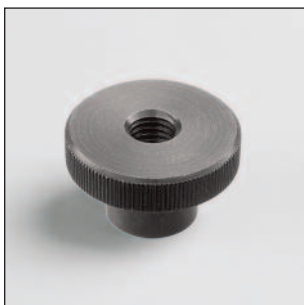
**3772D****DIN 466 TUERCA MOLETEADA CON CUELLO Y ROSCA DIRECTA**

Código	D	H	d	d1	h1
377200030	12	7,5	M3	6	2,5
377200040	16	9,5	M4	8	3,5
377200050	20	11,5	M5	10	4
377200060	24	15	M6	12	5
377200080	30	18	M8	16	6
377200100	36	23	M10	20	8
377200120	40	25	M12	22	10

Rosca directa pasante.  
Fe: Acero calidad 5, pavonado.  
El código 377200120 no cumple  
con la norma DIN indicada.

## 3772D DIN 466 TUERCA MOLETEADA CON CUELLO Y ROSCA DIRECTA EN INOX

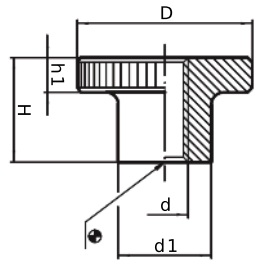

Código	D	H	d	d1	h1
377200240	16	9,5	M4	8	3,5
377200250	20	11,5	M5	10	4
377200260	24	15	M6	12	5
377200280	30	18	M8	16	6
377200300	36	23	M10	20	8

Rosca directa pasante.  
INOX: acero inoxidable 1.4305, Mate.



## 3882 POMO GRAFILADO TK

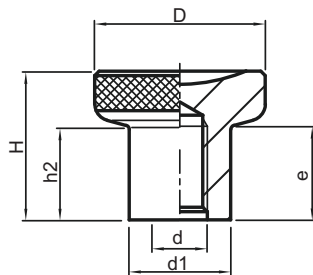

Código	D	H	h2	d	e	d1
388200023	21	18	10,5	M5	10	12,5
388200025	25	22,5	14	M6	12	14,5
388200028	31	27	17	M8	15	18,5
388200029	31	27	17	M10	17	18,5

Agujero roscado.  
Fe: Acero pavonado.

## 3882 POMO TK DE ACERO INOXIDABLE

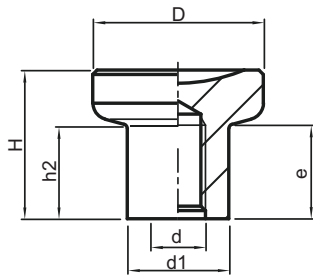

Código	D	H	h2	d	e	d1
388200103	21	18	10,5	M5	10	12,5
388200105	25	22,5	14	M6	12	14,5
388200108	31	27	17	M8	15	18,5
388200109	31	27	17	M10	17	18,5

Agujero roscado.  
INOX: Acero inoxidable 1.4305.  
Acabado pulido.

