

















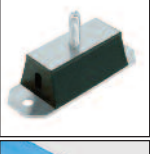

# Tecnodin **Antivibration** Mounts

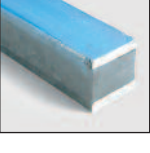
Page		Page	
95		100	
95		100	
96		101	
96		101	
97		101	
97		102	
97		102	
98			
98			
99			
99			
100			

## 4101 RAPIDO ANTI-VIBRATION MOUNT

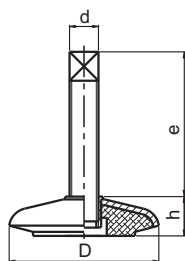

Code	D	d	e	h	Cd	Ce
410108012	80	M12	53	27	320	900
410111014	110	M14	93	32	550	1500
410114016	140	M16	91	39	750	2000
410120020	200	M20	113	62	1450	3600

Zinc plated steel base.  
Stud with two washers and two nuts for adjusting.  
Rubber compound oil and slide proof.  
Cd: Max. dynamic load (Kg).  
Ce: Max. static load (Kg).

## 4103 MAQUINAS ANTI-VIBRATION MOUNT

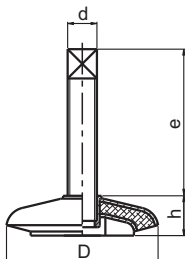

Code	D	d	e	h	Cd	Ce
410308012	80	M12	53	27	400	1200
410311014	110	M14	93	32	650	1900
410314016	140	M16	91	39	900	2850
410320020	200	M20	113	62	1800	6000

Zinc plated steel base.  
Stud with two washers and two nuts for adjusting.  
Rubber compound oil and slide proof.  
An intermediate lay of rubber gives higher capacity and vibration control.  
Cd: Max. dynamic load (Kg).  
Ce: Max. static load (Kg).

## 4104 ANTI-VIBRATION FEET

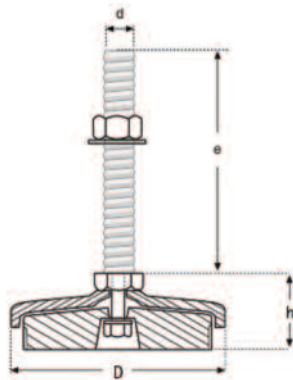

Code	D	h	d	e	Ce
410404025	40	25	M10	50	600
410405027	50	27	M12	75	700
410408031	80	31	M12	100	800
410412035	120	35	M16	100	1000
410416036	160	36	M20	150	2000
410420060	200	60	M20	150	3000

Rubber NBR 80° shore.  
Zinc plated steel revolving spindle.  
Spindle assembled to the base.  
Ce: Max. static load (Kg).

## 4105 ANTI-VIBRATION LEVELING FEET

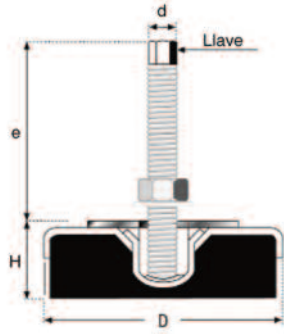

Code	D	H	d x pitch	e	Wrench	Ce
410508045	80	45	M12x1,25	100	12	700
410512045	120	45	M16x1,50	120	15	1000
410516045	160	45	M20x1,50	150	15	1500
410520055	200	55	M20x2,50(*)	160	25	4000

Rubber NBR 80° shore.  
 Height adjustable base.  
 Zinc plated steel spindle.  
 Fine Thread square headed bolt spindle.  
 (\*) Standard pitch.  
 Base and spindle not assembled.  
 Ce: Max. static load (Kg).

## 4111 P ANTI-VIBRATION MOUNT

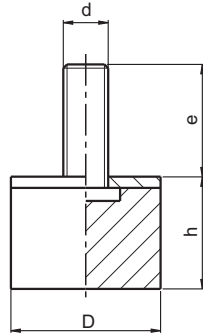

NR Rubber Compound 60°±5° shore A.  
 Zinc plated steel stud.  
 Used like feet for light machinery.  
 Cp: Max. compression load (Kg).  
 Different sizes on demand.

Code	D	h	d	e	Cp
411101510	15	10	M4	10	10
411101015	15	15	M4	14	10
411101610	16	10	M5	12	12
411102010	20	10	M6	16	16
411102015	20	15	M6	16	18
411102020	20	20	M6	16	18
411102025	20	25	M6	16	18
411102030	20	30	M6	16	16
411102515	25	15	M6	18	29
411102520	25	20	M6	18	29
411102525	25	25	M6	18	29
411102530	25	30	M8	20	29
411103010	30	10	M8	23	42
411103015	30	15	M8	23	42
411103020	30	20	M8	23	42
411103025	30	25	M8	23	42
411103030	30	30	M8	23	38
411103040	30	40	M8	23	38
411104020	40	20	M8	23	57
411104030	40	30	M8	23	75
411104035	40	35	M8	23	75
411104040	40	40	M10	28	75
411105020	50	20	M10	28	117
411105030	50	30	M10	28	117
411105040	50	40	M10	28	117
411105045	50	45	M10	28	117
411105050	50	50	M10	28	117
411106020	60	20	M12	37	169
411106030	60	30	M12	37	169
411106040	60	40	M12	37	169
411106050	60	50	M12	37	169
411107525	75	25	M12	37	265
411107540	75	40	M12	37	265
411107550	75	50	M12	37	265
411110040	100	40	M16	45	471
411110050	100	50	M16	45	471
411110080	100	80	M16	57	380

## 4110 PSS STAINLESS STEEL ANTI-VIBRATION MOUNT



**INOX**  
Stainless  
Steel

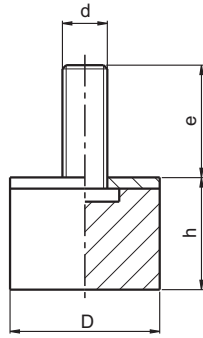

NR Rubber Compound  $60^{\circ}\pm 5^{\circ}$  shore A.  
Stainless steel screw and washer AISI 304.  
Screw pressed on the washer.  
Cp: Max. compression load (Kg).

Code	D	h	d	e	Cp
411091515	15	15	M4	14	15
411092015	20	15	M6	16	34
411092520	25	20	M6	18	45
411093030	30	30	M8	23	61
411094030	40	30	M8	23	98

## 4112 PF ANTI-VIBRATION MOUNT

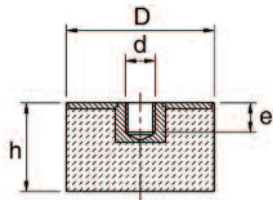

NR Rubber Compound  $60^{\circ}\pm 5^{\circ}$  shore A.  
Threaded blind hole.  
Zinc plated steel washers.  
Cp: Max. compression load (Kg).

Code	D	h	d	e	Cp
411202518	25	18	M6	9	29
411202520	25	20	M6	8	29
411203020	30	20	M8	6	42
411204030	40	30	M8	10	75
411205020	50	20	M10	10	117
411205030	50	30	M10	9	117

## 4113 SQUARE ANTI-VIBRATION MOUNT

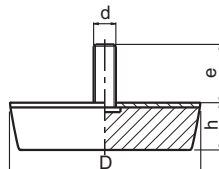

NBR Rubber Compound  $70^{\circ}\pm 5^{\circ}$  shore A.  
Zinc plated steel stud.  
Used like feet for light machinery.  
Cp: Max. compression load (Kg).

Code	D	h	d	e	Cp
411308010	80x80	30	M10	27	450
411312012	120x120	30	M12	36	900

## 4114 RUBBER PLATE

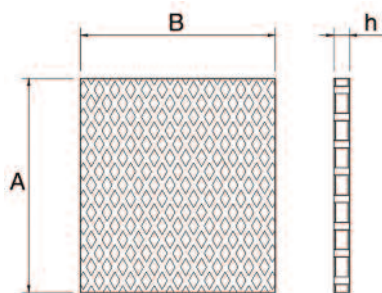
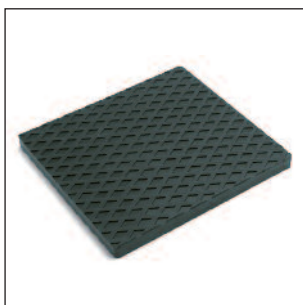

NBR Rubber compound.  
Cp: Max. compression load (Kg/cm<sup>2</sup>).

Code	A	B	h	Cp
411422000	220	201	16	15

## 4117 AV ANTI-VIBRATION MOUNT

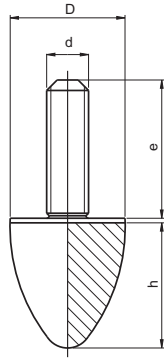

NR Rubber compound  $65^{\circ}\pm 5^{\circ}$  shore A.  
Zinc plated steel stud.  
Used as shock-absorbers, feet and stroke end.  
Cp: Max. compression load(Kg).

Code	D	h	d	e	Cp
411702522	25	22	M6	20	20
411702530	25	30	M6	18	18
411703036	30	36	M8	23	25
411704030	40	30	M8	23	29
411704060	40	60	M8	23	28
411705050	50	50	M10	28	54
411705064	50	64	M8	35	50
411706060	60	60	M12	33	72
411707570	75	70	M12	37	117
411710085	100	85	M16	46	330

## 4121 M ANTI-VIBRATION MOUNT

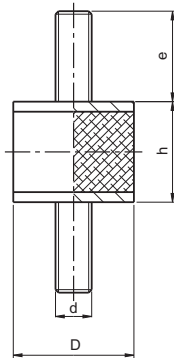

NR Rubber compound  $60^{\circ}\pm 5^{\circ}$  shore A.  
Zinc plated steel stud.  
More sizes on demand.  
Cp: Max. compression load (Kg).  
Cz: Max. shear load (Kg).

Code	D	h	d	e	Cp	Cz
412101310	13	10	M5	10	15	2
412101515	15	15	M4	14	15	2
412102010	20	10	M6	16	36	3
412102015	20	15	M6	16	34	4
412102020	20	20	M6	16	34	2
412102515	25	15	M6	18	35	5
412102520	25	20	M6	18	45	5
412102530	25	30	M6	18	34	3
412103020	30	20	M8	23	66	9
412103030	30	30	M8	23	61	7
412103040	30	40	M8	23	55	5
412104030	40	30	M8	23	98	15
412104035	40	35	M8	23	88	13
412105020	50	20	M10	28	168	21
412105030	50	30	M10	28	158	19
412105040	50	40	M10	28	143	17
412105050	50	50	M10	28	133	13
412196030	60	30	M12	37	172	36
412106550	65	50	M12	37	230	23
412107525	75	25	M12	37	382	89
412107540	75	40	M12	37	377	79
412107550	75	50	M12	37	372	69
412110050	100	50	M16	45	560	99
412110055	100	55	M16	45	635	79
412110060	100	60	M16	45	587	49

## 4120 MSS STAINLESS STEEL ANTI-VIBRATION MOUNT



**INOX**  
Stainless  
Steel

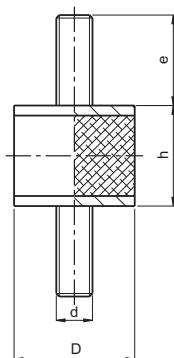

NR Rubber compound  $60^{\circ}\pm 5^{\circ}$  shore A.  
Stainless steel screw and washer AISI 304.  
Cp: Max. compression load (Kg).  
Cz: Max. shear load (Kg).

Code	D	h	d	e	Cp	Cz
412091515	15	15	M4	14	15	2
412092015	20	15	M6	16	34	4
412092520	25	20	M6	18	45	5
412093030	30	30	M8	23	61	7
412094030	40	30	M8	23	98	15

## 4122 MF ANTI-VIBRATION MOUNT

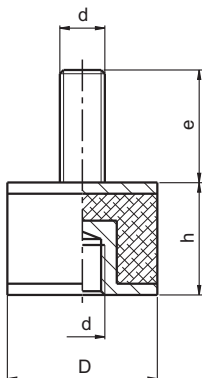

NR Rubber compound  $60^{\circ}\pm 5^{\circ}$  shore A.  
Zinc plated steel stud.  
More sizes on demand.  
Cp: Max. compression load (Kg).  
Cz: Max. shear load (Kg).

Code	D	h	d	e	Cp	Cz
412201515	15	15	M4	14	15	3
412202015	20	15	M6	16	34	3
412202020	20	20	M6	16	29	2
412202520	25	20	M6	18	45	5
412202530	25	30	M6	18	35	3
412203020	30	20	M8	23	66	9
412203030	30	30	M8	23	61	7
412203040	30	40	M8	23	54	5
412204030	40	30	M8	23	98	15
412204035	40	35	M8	23	88	13
412205020	50	20	M10	28	169	21
412205030	50	30	M10	28	159	20
412205040	50	40	M10	28	144	18
412205050	50	50	M10	28	134	14
412206550	65	50	M12	37	230	23
412207525	75	25	M12	37	382	89
412207540	75	40	M12	37	378	78
412207550	75	50	M12	37	373	68
412210050	100	50	M16	45	660	98
412210055	100	55	M16	45	636	78
412210060	100	60	M16	45	586	48

## 4123 2F ANTI-VIBRATION MOUNT

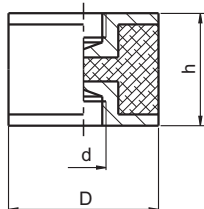

NR Rubber compound  $60^{\circ}\pm 5^{\circ}$  shore A.  
Zinc plated steel insert.  
More sizes on demand.  
Cp: Max. compression load (Kg).  
Cz: Max. shear load (Kg).

Code	D	h	d	Cp	Cz
412301515	15	15	M4	15	2
412302020	20	20	M6	20	2
412302520	25	20	M6	45	5
412302530	25	30	M6	35	3
412303020	30	20	M8	66	9
412303030	30	30	M8	61	8
412303040	30	40	M8	54	5
412304030	40	30	M8	98	15
412304035	40	35	M8	108	13
412305030	50	30	M10	169	19
412305040	50	40	M10	144	17
412305050	50	50	M10	134	13
412306050	60	50	M10	200	24
412307530	75	30	M12	390	90
412307540	75	40	M12	378	78
412307550	75	50	M12	373	68
412310050	100	50	M16	660	98
412310055	100	55	M16	636	78
412310060	100	60	M16	590	49

## 4125 SGOLATI ANTI-VIBRATION MOUNT

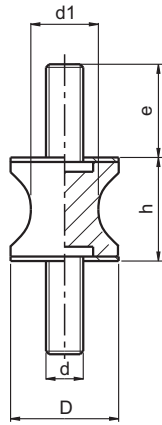

Code	D	h	d1	d	e	Cp	Cz
412501207	12	15	7	M4	10	3	0.8
412502510	25	20	10	M6	18	50	3
412503024	30	20	24	M8	23	60	10
412504019	40	30	19	M8	20	80	6
412504027	40	30	27	M8	20	100	8

NR Rubber compound  $60^{\circ}\pm 5^{\circ}$  shore A  
Zinc plated steel studs.  
Specially suitable to fix equipments being very sensitive to vibrations, control panels, light machinery, suspended instruments panels.  
Cp: Max. compression load (Kg).  
Cz: Max. shear load (Kg).

## 4131 SIRIO ANTI-VIBRATION MOUNT



Code	D	E	d2	h	k	L	s	d1	d	Hardness	Ce	Version
413105008	48	19	6.5	23	68	80	1.5	8.5	-	$60^{\circ}\pm 5^{\circ}$	102	-
413106010	62	25	8.5	30	85	100	2	10.5	-	$60^{\circ}\pm 5^{\circ}$	214	-
413109016	92	40.5	10.5	44	110	130	3	16.5	-	$60^{\circ}\pm 5^{\circ}$	343	-
413111024	119	50.5	16.5	48	160	190	4	24.5	-	$60^{\circ}\pm 5^{\circ}$	641	-
413116030	158	80	16.5	60	200	230	5	30.5	-	$60^{\circ}\pm 5^{\circ}$	1211	-
413106310	62	25	8.5	30	85	100	2	-	M10	$60^{\circ}\pm 5^{\circ}$	214	CD
413109316	92	40.5	10.5	44	110	130	3	-	M16	$60^{\circ}\pm 5^{\circ}$	343	CD
413111324	119	50.5	16.5	48	160	190	4	-	M24	$60^{\circ}\pm 5^{\circ}$	641	CD
413106510	62	39	8.5	30	85	100	2	14	M10	$55^{\circ}\pm 5^{\circ}$	250	T
413109516	92	60	10.5	44	110	130	3	20	M16	$55^{\circ}\pm 5^{\circ}$	360	T
413111916	119	82	16.5	48	160	190	4	21	M16	$55^{\circ}\pm 5^{\circ}$	650	T

NR Rubber compound shore A and zinc plated steel.  
Cushy-float flanged mountings, used when good transversal flexibility is required, where frequency are between 8 and 12 Hz.  
Used in diesel engines, marine engines, refrigerators, agricultural machines, generators. Version T recommended for marine motors, tractor cabins, etc.  
Ce: Max. static load (Kg).

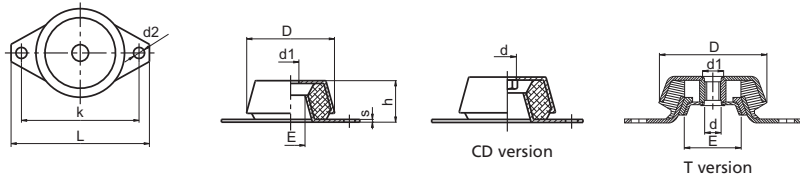

## 4129 CONICAL ANTI-VIBRATION MOUNT



Code	A	B	C	D	E	F	G	H	I	L	Cp
412906012	12	16.5	2.5	51	60	11	68	80	106	-	200
412907816	16	19.5	3.5	56	78	11	65	90	80	107	400
412909316	16	20	4.3	81	93	11	74	100	90	120	900
412910920	20	23	4.5	95	109	11	92	120	112	140	1600

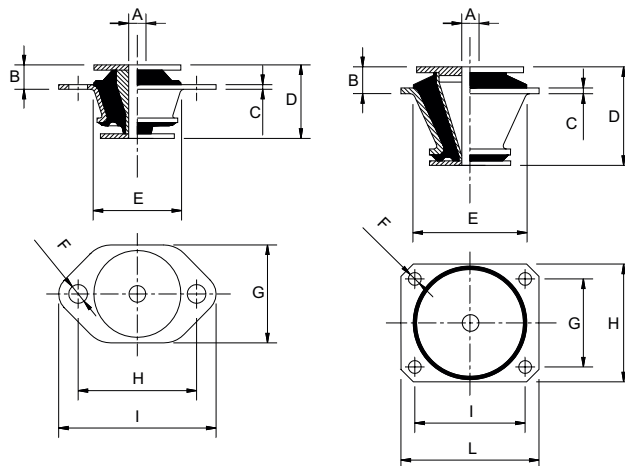

412906012

412907813 / 412909316 / 412910920

NR Rubber compound  $60^{\circ}\pm 5^{\circ}$  shore A.  
Zinc plated steel.  
Cp: Max. compression load (Kg).

## 4130 SQUARE BELL ANTI-VIBRATION MOUNT



Code	A	H	M	N	O	R	S	T	Hardness	Ce
413015355	12.5	51.5	M16	168	150	110	4	132	55°±5°	500
413015370	12.5	51.5	M16	168	150	110	4	132	70°±5°	600
413017355	13	63	M20	200	177	125	6	150	55°±5°	850

NR Rubber compound shore A.  
Welded threaded nut.  
Zinc plated steel sheet.  
Ce: Max. static load(Kg).

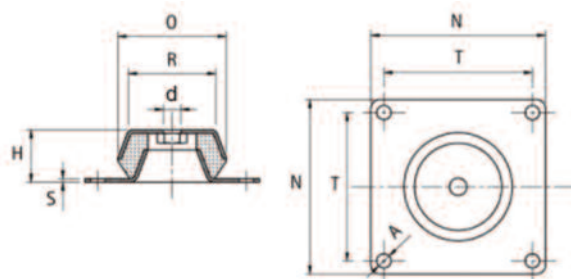

## 4130T SQUARE BELL ANTI-VIBRATION MOUNT TEAR RESISTANT

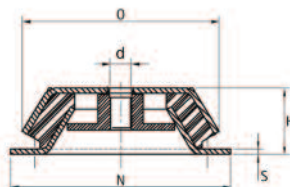

Code	H	d	N	O	S	Ce
413015555	51.5	M16	168	150	4	500
413017555	63	M20	200	177	6	850

NBR Rubber compound 55°±5° shore A.  
With vulcanized threaded shock-absorber.  
Zinc plated steel sheet.  
This model includes an anti-vibration pad with failsafe. This leads to a reliable machine fixing that stands up to the rigours of firing a powerful combustion engine.  
The NBR compound of the machine base offers optimal stability and high resistance to oils.  
Ce: Max. static load(Kg).

## 4133 LONG-LIFE ANTI-VIBRATION MOUNT

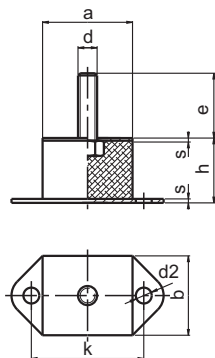
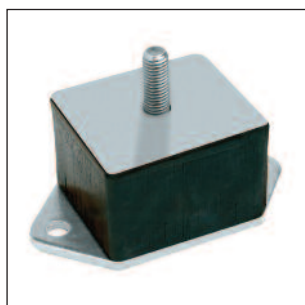

Code	b	a	k	h	e	d2	d	s	Cp
413308075	70	80	105	54	35	11	M12	5	950

NBR Rubber compound 60°±5° shore A.  
Zinc plated steel stud.  
Oil and heat resistant.  
Used as vehicle suspension springs, conveyor systems, electric engines.  
Cp: Max. load compression (Kg).



## 4135 REBO ANTI-VIBRATION MOUNT

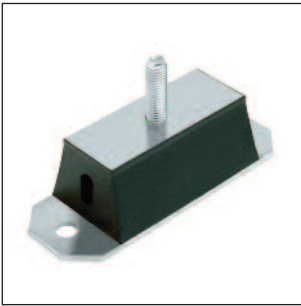

NR Rubber compound  $60^{\circ} \pm 5^{\circ}$  shore A.  
 Zinc plated steel stud.  
 Oil resistant, vertical and transversal flexibility (the rubber is specially flexible in this model).  
 Used in electric fans, motor pumps, compressors, machine tools, generating sets.  
 Cp: Max. compression load (Kg).

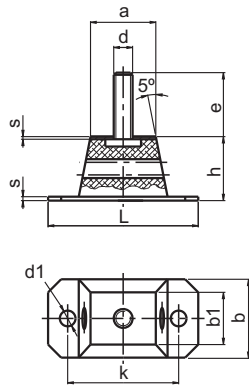

Code	d1	b	b1	L	a	k	s	h	e	d	Cp
413500050	12.2	60	40	115	50	85	3	46	37	M12	500
413500100	12.2	60	40	165	100	135	3	46	37	M12	1200
413500150	12.2	60	40	215	150	185	3	46	37	M12	1400
413500200	12.2	60	40	265	200	235	3	46	37	M12	1600

## 4137 BARRA ANTI-VIBRATION MOUNT

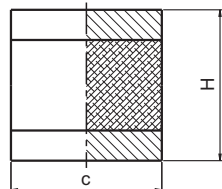
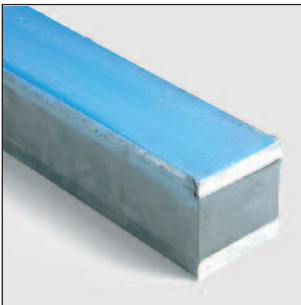

Code	c	H	Long.	C
413705000	50	50	1000	14
413706000	60	60	1000	14
413707000	70	60	1000	14
413708000	80	60	1000	14
413710000	100	60	1000	14

The antivibrating bars have been built to support high working loads. They are particularly indicated for any type of generating set.

The antivibrating bars are manufactured in synthetic rubber, hardness  $65^{\circ}$  shore A ( $\pm 5^{\circ}$ ).  
 The metal parts are blue lacquered.  
 $C = \text{Kg}/\text{cm}^2$ .